

Pacific Wave

GLIF '09 Update

David Reese

Pacific Wave GOLE

- Operated jointly by PNWGP and CENIC
- Distributed GOLE
 - Seattle, WA
 - Sunnyvale/San Jose, CA
 - Los Angeles, CA
- Upgrade from 1x10GE to 2x10GE
- Working on deploying GLIF naming standards within Pacific Wave naming/numbering scheme

Pacific Wave GOLE

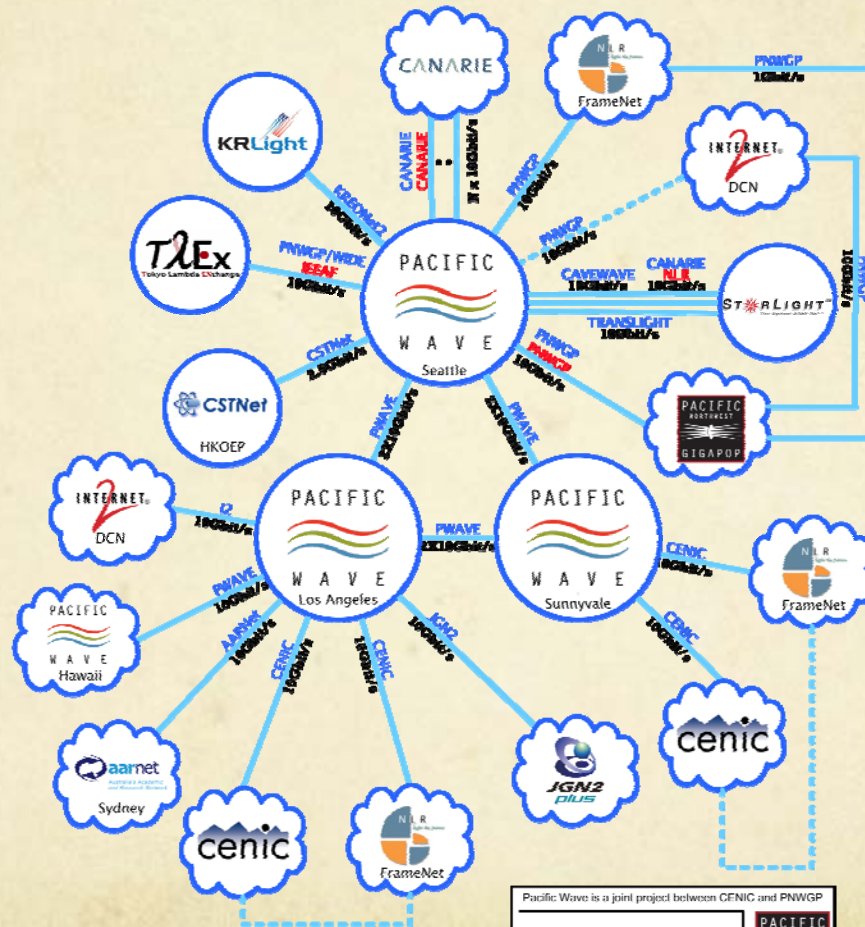

Pacific Wave GOLE		
Schylar Batey	9/18/2009	PNWGP

Pacific Wave is a joint project between CENIC and PNWGP

- PWAVE = Link Operator
- PWAVE = Link Provider
- 10bit/s = Speed
- - - = Indirect Connectivity



Pacific Wave: Seattle

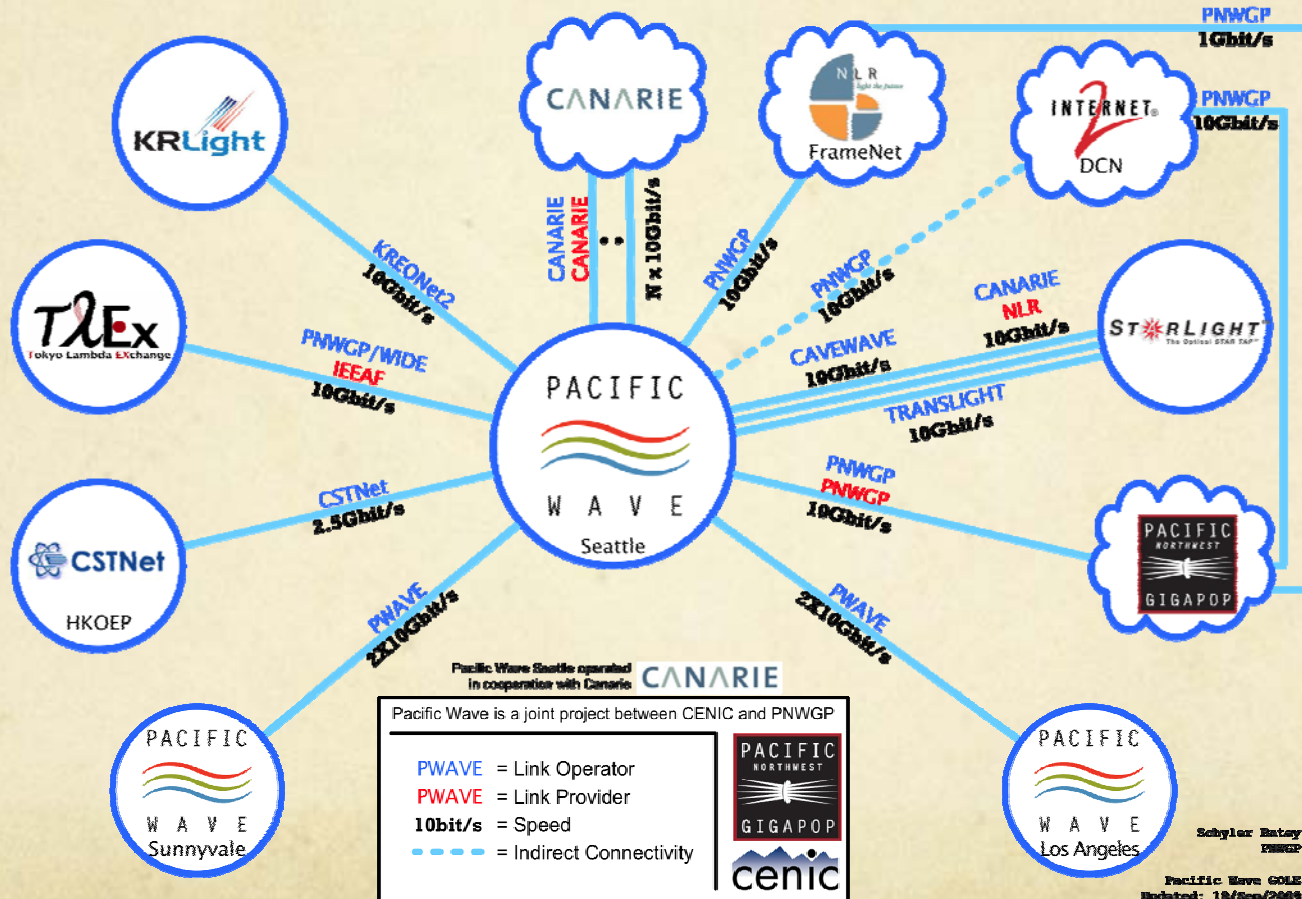

Pacific Wave: Sunnyvale

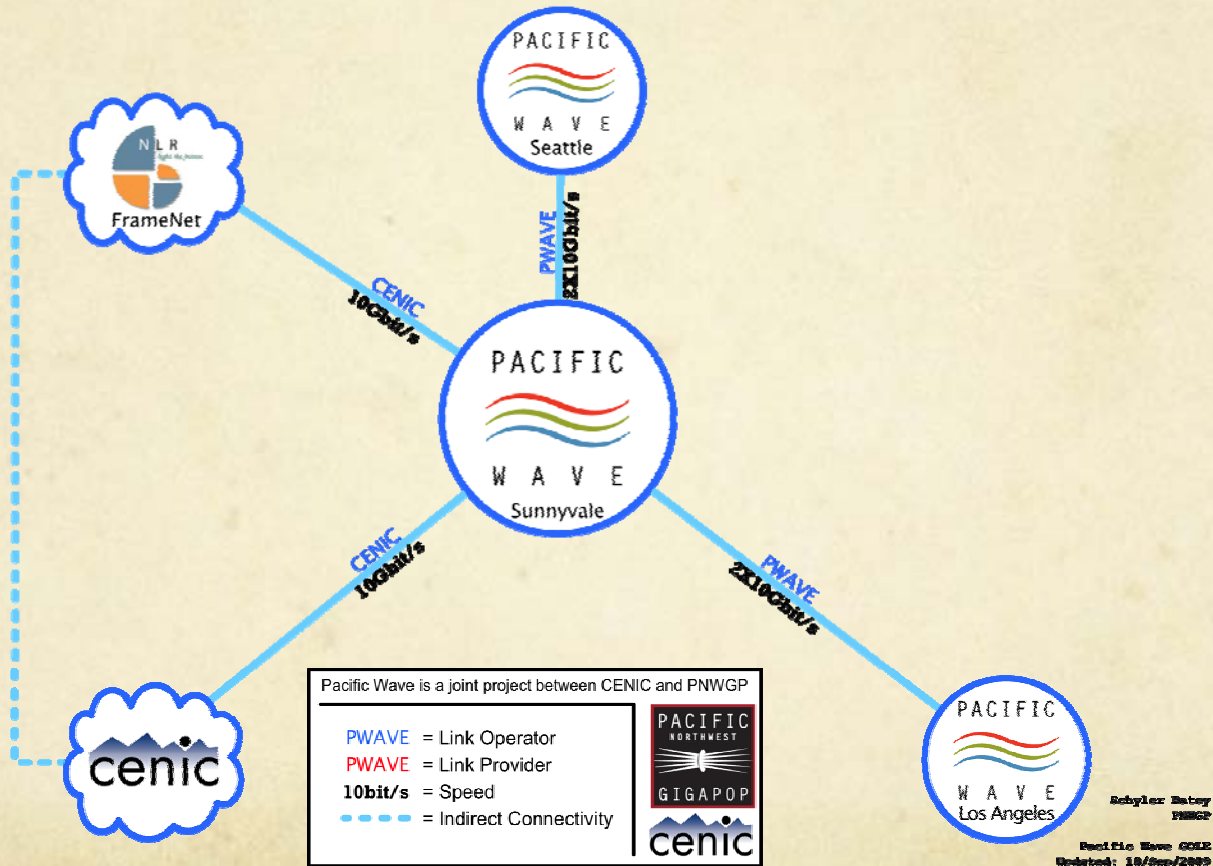

Pacific Wave: Los Angeles

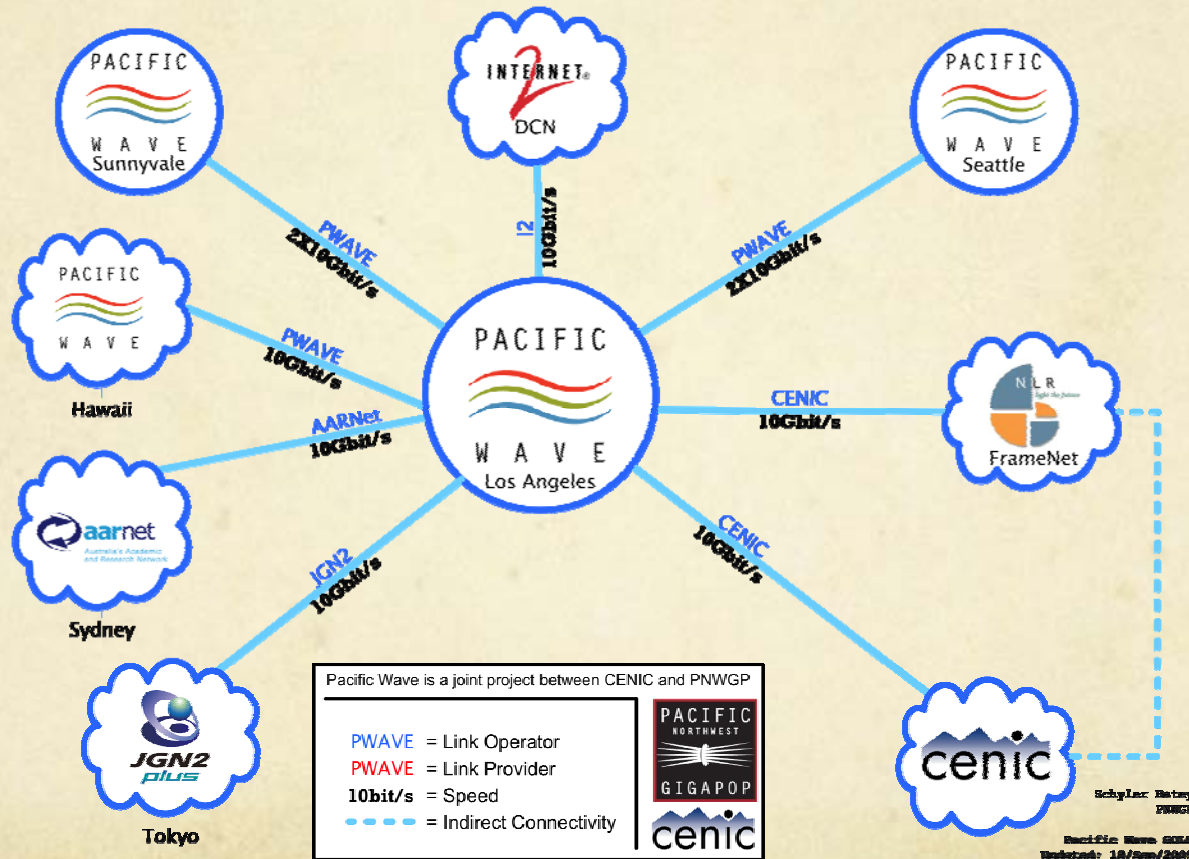

Architecture

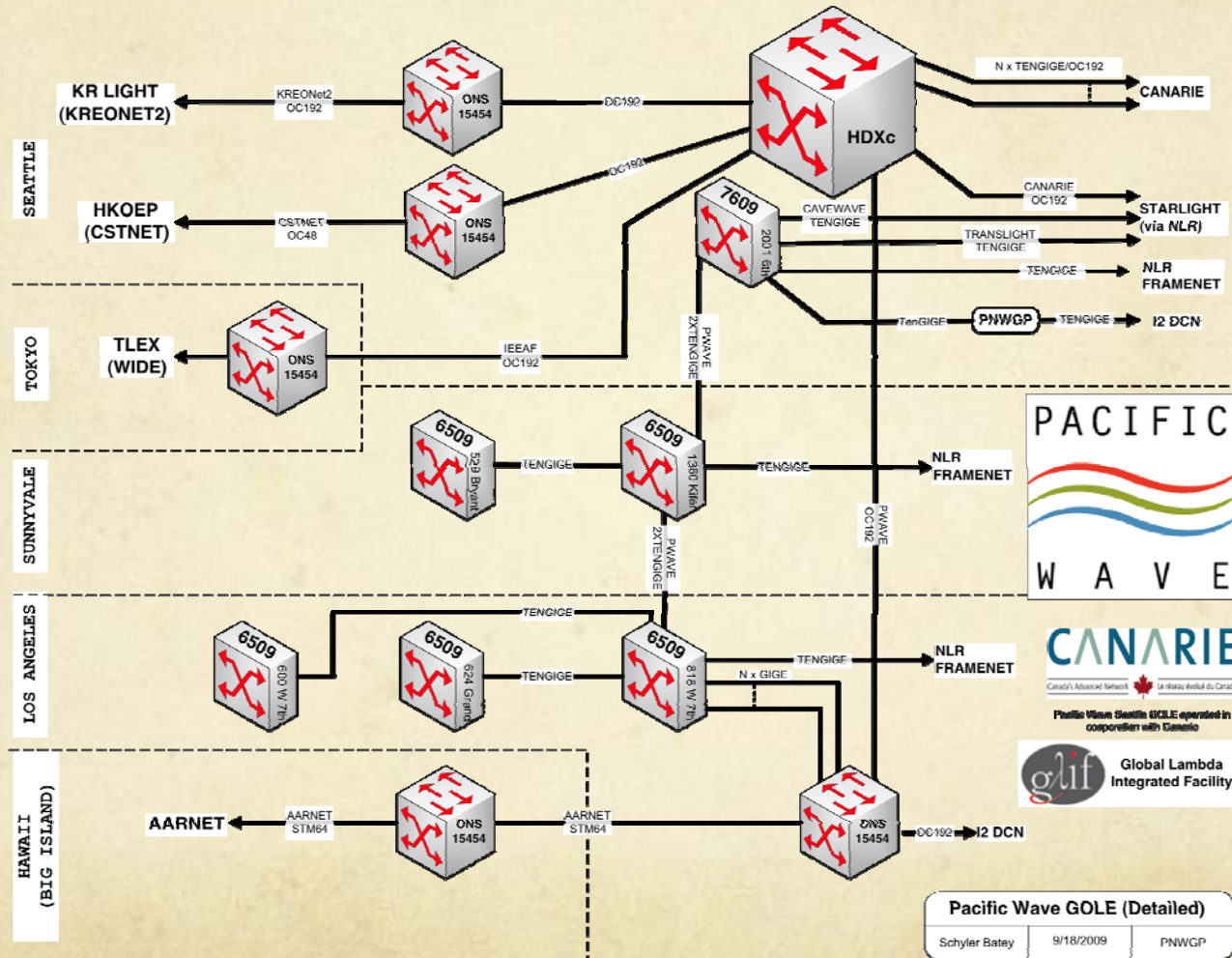

Pacific Wave at SC09

Pacific Wave access to SC09 via NLR Framenet

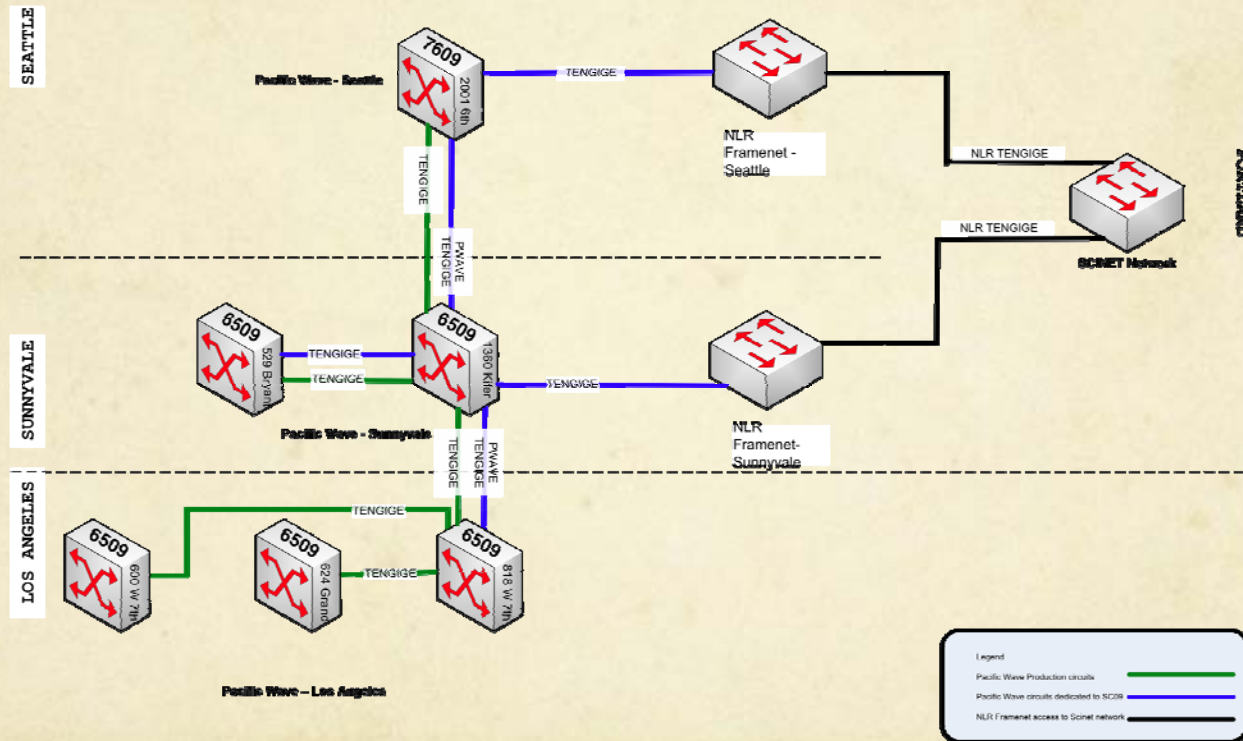

Pacific Wave SC09 Access

Schlyer Batey

10/02/2009

PNWGP